

Shelly® i3

INITIAL INCLUSION

Before installing/mounting the Device ensure that the grid is powered off (turned down breakers). Connect the Device to the power grid and install it in the console behind the switch/power socket following the scheme that suits the desired purpose. For more information about the Bridge, please visit: <http://shelly-api-docs.shelly.cloud/#shelly-family-overview> or contact us at: developers@shelly.cloud You may choose if you want to use Shelly with the Shelly Cloud mobile application and Shelly Cloud service. You can also familiarize yourself with the instructions for Management and Control through the embedded Web interface.

Control your home with your voice

All Shelly devices are compatible with Amazon Echo and Google Home. Please see our step-by-step guide on: <https://shelly.cloud/compatibility/>



MOBILE APPLICATION FOR MANAGEMENT OF SHELLY®



Shelly Cloud gives you the opportunity to control and adjust all Shelly® Devices from anywhere in the world. You only need an internet connection and our mobile application, installed on your smartphone or tablet.

Registration

The first time you load the Shelly Cloud mobile app, you have to create an account which can manage all your Shelly® devices.

Forgotten Password

In case you forget or lose your password, just enter the e-mail address you have used in your registration. You will then receive instructions to change your password.

⚠ WARNING! *Be careful when you type your e-mail address during the registration, as it will be used in case you forget your password.*

First steps

After registering, create your first room (or rooms), where you are going to add and use your Shelly devices.

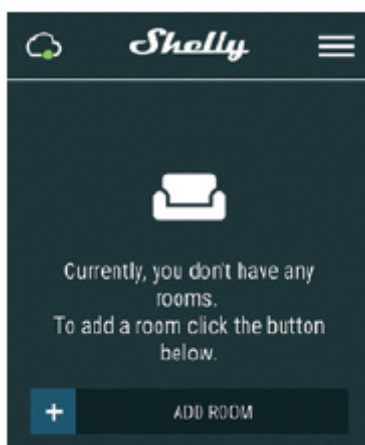

Shelly Cloud gives you the opportunity to create scenes for automatically turning on or off of the Devices at predefined hours or based on other parameters like temperature, humidity, light etc. (with available sensors in Shelly Cloud). Shelly Cloud allows easy control and monitoring using a mobile phone, tablet or PC.

Device Inclusion

To add a new Shelly device, install it to the power grid following the Installation Instructions included with the Device.

Step 1

After the installation of Shelly following the Installation Instructions and the power is turned on, Shelly will create its own WiFi Access Point (AP).

⚠ WARNING! *In case the Device has not created its own AP WiFi network with SSID like **shellyix3-35FA58**, please check if the Device is connected accordingly to the Installation Instructions. If you still do not see an active WiFi network with SSID like*

shellyix3-35FA58 or you want to add the Device to another Wi-Fi network, reset the Device. You will need to have physical access to the Device. Press and hold the reset button for 10 seconds. After 5 seconds, the LED should start blinking fast, after 10 seconds it should blink faster. Release the button. Shelly should return to AP mode. If not, please repeat or contact our customer support at: support@shelly.cloud

Step 2

Choose "Add Device".

In order to add more Devices later, use the app menu at the top right corner of the main screen and click "Add Device". Type the name (SSID) and password for the WiFi network, to which you want to add the Device.

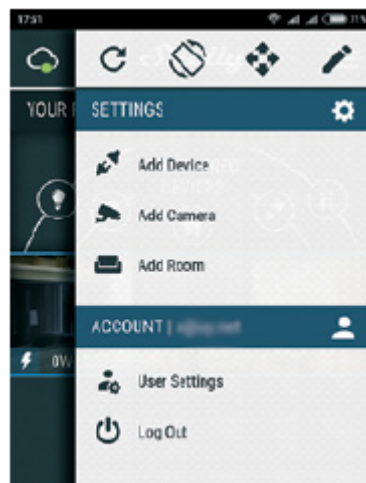

Step 3

If using iOS: you will see the following



Press the home button of your iPhone/iPad/iPod. Open Settings > WiFi and connect to the WiFi network created by Shelly, e.g. **shellyix3-35FA58**. If using Android: your phone/tablet will automatically scan and include all new Shelly Devices in the WiFi

network that you are connected to. Upon successful Device Inclusion to the WiFi network you will see the following pop-up:



Step 4:

Approximately 30 seconds after discovery of any new Devices on the local WiFi network, a list will be displayed by default in the “Discovered Devices” room.

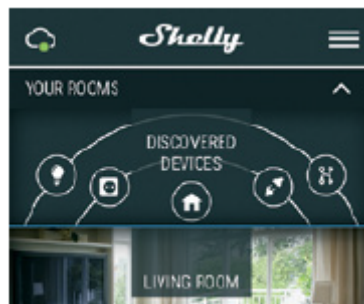

Step 5:

Enter Discovered Devices and choose the Device you want to include in your account.



Step 6:

Enter a name for the Device (in the Device Name field). Choose a Room, in which the Device has to be positioned. You can choose an icon or add a picture to make it easier to recognize. Press "Save Device".

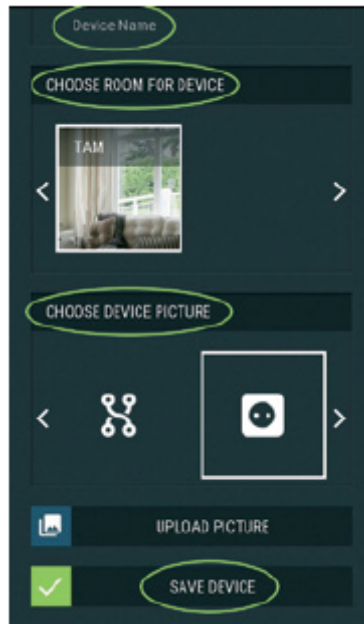

Step 7:

To enable connection to the Shelly Cloud service for remote control and monitoring of the Device, press "YES" on the following pop-up.



Shelly Device Settings

After your Shelly device is included in the app, you can control it, change its settings and automate the way it works. To enter the details menu of the respective Device, simply click on it's name. From the details menu you may control the Device, as well as edit its appearance and settings.

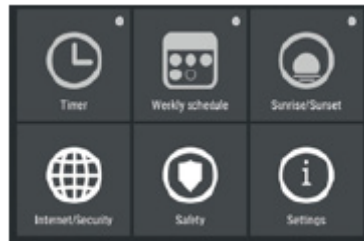

Internet/Security

WiFi Mode - Client: Allows the device to connect to an available WiFi network. After typing the details in the respective fields, press Connect.

WiFi Client Backup: Allows the device to connect to an available WiFi network, as a secondary (backup), if your primary WiFi network becomes unavailable. After typing the details in the respective fields, press Set.

WiFi Mode - Access Point: Configure Shelly to create a Wifi Access point. After typing the details in the respective fields, press Create Access Point.

Cloud: Enable or Disable connection to the Cloud service.

Restrict Login: Restrict the web interface of Shelly with a Username and Password. After typing the details in the respective fields, press Restrict Shelly.

Actions

Shelly i3 may send commands for control of other Shelly devices, by using a set of URL endpoints. All URL actions can be found at: <https://shelly-api-docs.shelly.cloud/>

- Button Switched ON: To send a command to an URL, when the button is switched ON. Works only when the button is configured as **Toggle**.
- Button Switched OFF: To send a command to an URL, when the button is switched OFF. Works only when the button is configured as **Toggle**.
- Button Short Press: To send a command to an URL, when the button is pressed once. Works only when the button is configured as **Momentary**.
- Button Long Press: To send a command to an URL, when the button is pressed and hold. Works only when the button is configured as **Momentary**.
- Button 2x Short Press: To send a command to an URL, when the button is pressed two time. Works only when the button is configured as **Momentary**.
- Button 3x Short Press: To send a command to an URL, when the button is pressed three times. Works only when the button is configured as **Momentary**.

- Button Short + Long Press: To send a command to an URL, when the button is pressed once and then pressed and held. Works only when the button is configured as **Momentary**.
- Button Long + Short Press: To send a command to an URL, when the button is pressed and held, and then pressed again. Works only when the button is configured as **Momentary**.

Settings

Button Type

- Momentary – When using a button.
- Toggle Switch – When using a switch.
- Reverse inputs - If you enable this option, the buttons On/Off position will be inverted.

Long Push Duration

- Min - the minimal time, that the button is pressed and hold, in order to trigger Long Push command. Range (in ms): 100-3000
- Max - the maximum time that the button is pressed and held, in order to trigger Longpush command. Range for max (in ms): 200-6000

Multi Push

The maximum time, between pushes, when triggering a multipush action. Range: 100-1000

Firmware Update

Update the firmware of Shelly, when a new version is released.

Time Zone and Geo-location

Enable or Disable the automatic detection of Time Zone and Geo-location.

Factory Reset

Return Shelly to its factory default settings.

Device Reboot

Reboots the Device

Device Information

- Device ID - Unique ID of Shelly
- Device IP - The IP of Shelly in your Wi-Fi network

Edit Device

- Device Name
- Device Room
- Device Picture

When you are done, press **Save Device**.

THE EMBEDDED WEB INTERFACE

Even without the mobile app, Shelly can be set and controlled through a browser and WiFi connection of a mobile phone, tablet or PC.

Abbreviations Used:

- **Shelly-ID** – the unique name of the Device. It consists of 6 or more characters. It may include numbers and letters, for example **35FA58**.
- **SSID** – the name of the WiFi network, created by the Device, for example **shellyix3-35FA58**.
- **Access Point (AP)** – the mode in which the Device creates its own WiFi connection point with the respective name (SSID).
- **Client Mode (CM)** – the mode in which the Device is connected to another WiFi network.

Installation/Initial inclusion

Step 1

Install Shelly to the power grid following the schemes described above and place it into the console. After turning the power on Shelly will create its own WiFi network (AP).

⚠ WARNING! *In case the Device has not created its own AP WiFi network with SSID like **shellyix3-35FA58**, please check if the Device is connected accordingly to the Installation Instructions. If you still do not see an active WiFi network with SSID like **shellyix3-35FA58** or you want to add the Device to another Wi-Fi network, reset the Device. You will need to have physical access to the Device. Press and hold the reset button for 10 seconds. After 5 seconds, the LED should start blinking fast, after 10 seconds it should blink faster. Release the button. Shelly should return to AP mode. If not, please repeat or contact our customer support at: support@Shelly.cloud*

Step 2

When Shelly has created its own WiFi network (own AP), with name (SSID) such as **shellyix3-35FA58**. Connect to it with your phone, tablet or PC.

Step 3

Type **192.168.33.1** into the address field of your browser to load the web interface of Shelly.

General - Home Page

This is the homepage of the embedded web interface. Here you will see information about:

- Input 1, 2, 3
- Current state (on/off)
- Power Button
- Connection to Cloud
- Present time
- Settings

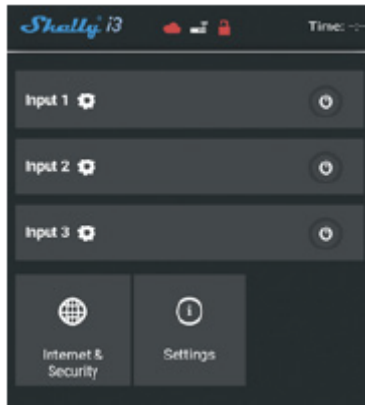

Internet/Security

WiFi Mode - Client: Allows the device to connect to an available WiFi network. After typing the details in the respective fields, press Connect.

WiFi Client Backup: Allows the device to connect to an available WiFi network, as a secondary (backup), if your primary WiFi network becomes unavailable. After typing the details in the respective fields, press **Set**.

WiFi Mode - Access Point: Configure Shelly to create a Wifi Access point. After typing the details in the respective fields, press Create Access Point.

Cloud: Enable or Disable connection to the Cloud service.

Restrict Login: Restrict the web interface of Shelly with a Username and Password. After typing the details in the respective fields, press Restrict Shelly.

SNTP Server: You can change the default SNTP server. Enter the address, and click Save.

Advanced - Developer Settings:

Here you can change the action execution via CoAP (CoIoT) or via MQTT.

⚠ WARNING! *In case the Device has not created its' own AP WiFi network with SSID like **shellyix3-35FA58**, please check if the Device is connected according to the Installation Instructions. If you still do not see an active WiFi network with SSID like **shellyix3-35FA58** or you want to add the Device to another Wi-Fi network, reset the Device. You will need to have physical access to the Device. Press and hold the reset button for 10 seconds. After 5 seconds, the LED should start blinking fast, after 10 seconds it should blink faster. Release the button. Shelly should return to AP mode. If not, please repeat or contact our customer support at: support@shelly.cloud*

Settings

Long Push Duration

- **Min** - the minimal time, that the button is pressed and hold, in order to trigger Longpush command. Range (in ms): 100-3000
- **Max** - the maximum time, that the button is pressed and hold, in order to trigger Longpush command. Range for max (in ms): 200-6000.

Multi Push

The maximum time (in ms), between pushes, when triggering a multipush action.
Range: 100-1000.

Firmware Update

Update the firmware of Shelly, when a new version is released.

Time Zone and Geo-location

Enable or Disable the automatic detection of Time Zone and Geo-location.

Factory Reset

Return Shelly to its factory default settings.

Device Reboot

Reboots the Device.

Device Information

- **Device ID** - Unique ID of Shelly
- **Device IP** - The IP of Shelly in your Wi-Fi network

Input menu

Actions: Shelly i3 may send commands for control of other Shelly devices, by using a set of URL endpoints. All URL actions can be found at: <https://shelly-api-docs.shelly.cloud/>

- Button Switched ON: To send a command to an URL, when the button is switched ON. Works only when the button is configured as Toggle.
- Button Switched OFF: To send a command to an URL, when the button is switched OFF. Works only when the button is configured as Toggle.
- Button Short Press: To send a command to an URL, when the button is pressed once. Works only when the button is configured as Momentary.
- Button Long Press: To send a command to an URL, when the button is pressed and held. Works only when button is configured as Momentary.
- Button 2x Short Press: To send a command to an URL, when the button is pressed two times. Works only when the button is configured as Momentary.
- Button 3x Short Press: To send a command to an URL, when the button is pressed three times. Works only when the button is configured as Momentary.
- Button Short + Long Press: To send a command to an URL, when the button is pressed once and then pressed and held. Works only when button is configured as Momentary.
- Button Long + Short Press: To send a command to an URL, when the button is pressed and held, and then pressed again. Works only when the button is configured as Momentary.

Button Type

- Momentary – When using a button.
- Toggle Switch – When using a switch.

- Reverse inputs - If you enable this option, the buttons On/Off position will be inverted.

SHELLY i3 WIFI SWITCH INPUT USER AND SAFETY GUIDE

This document contains important technical and safety information about the device and its safety use and installation. Before beginning the installation, please read this guide and any other documents accompanying the device carefully and completely. Failure to follow the installation procedures could lead to malfunction, danger to your health and life, violation of the law or refusal of legal and/or commercial guarantee (if any). Allterco Robotics is not responsible for any loss or damage in case of incorrect installation or improper operation of this device due to failure of following the user and safety instructions in this guide.

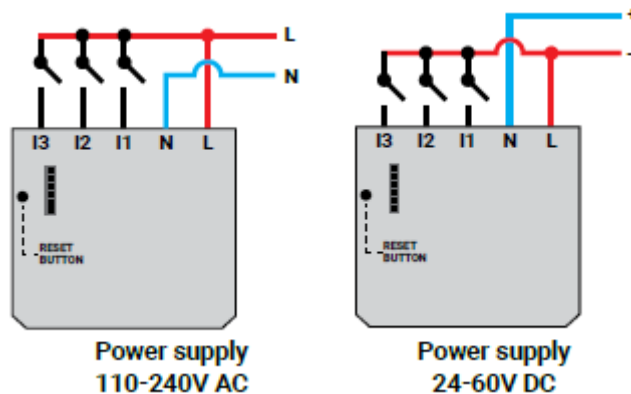

LEGEND

- **AC** Power supply (110V-240V):
- **N** - Neutral (Zero)
- **L** - Line (Phase)
- **DC** - Power supply (24V-60V):
- **N** - Neutral (+)
- **L** - Positive (-)
- **i1, i2, i3** - Communication inputs

The WiFi switch input Shelly i3 may send commands for control of other devices over the Internet. It is intended to be mounted into a standard in-wall console, behind power sockets and light switches or other places with limited space. Shelly may work as a standalone Device or as an accessory to another home automation controller.

Specification

- Power supply: 110-240V \pm 10% 50/60Hz AC; 24-60V DC
- Complies with EU standards: RED 2014/53/EU, LVD 2014/35/EU, EMC 2014/30/EU, RoHS2 2011/65/EU
- Working temperature: -40°C up to 40°C
- Radio signal power: 1mW
- Radio protocol: WiFi 802.11 b/g/n
- Frequency: 2412 - 2472 MHz (Max. 2483.5 MHz)
- Operational range (depending on local construction): up to 50 m outdoors, up to 30 m indoors
- Dimensions (HxWxL): 36,7x40,6x10,7 mm
- Electrical consumption: <1 W

Technical Information

- Control through WiFi from a mobile phone, PC, automation system or any other Device supporting HTTP and/or UDP protocol.
- Microprocessor management.

⚠ CAUTION! *Danger of electrocution. Mounting the Device to the power grid has to be performed with caution.*

⚠ CAUTION! *Do not allow children to play with the button/ switch connected to the Device. Keep the Devices for remote control of Shelly (mobile phones, tablets, PCs) away from children.*

Introduction to Shelly®

Shelly® is a family of innovative Devices, which allow remote control of electric appliances through mobile phone, PC or home automation systems. Shelly® uses WiFi to connect to the devices controlling it. They can be in the same WiFi network or they can use remote access (through the Internet). Shelly® may work standalone, without being managed by a home automation controller, in the local WiFi network, as well as through a cloud service, from everywhere the User has Internet access. Shelly® has an integrated web server, through which the User may adjust, control and monitor the Device. Shelly® has two WiFi modes - Access Point (AP) and Client mode (CM). To operate in Client Mode, a WiFi router must be located within the range of the Device. Shelly® devices can communicate directly with other WiFi devices through HTTP protocol. An API can be provided by the Manufacturer. Shelly® devices may be available for monitor and control even if the User is outside the range of the local WiFi network, as long as the WiFi router is connected to the Internet. The cloud function could be used, which is activated through the web server of the Device or through the settings in the Shelly Cloud mobile application. The User can register and access Shelly Cloud, using either

Android or iOS mobile applications, or any internet browser and the web site:
<https://my.Shelly.cloud/>.

Installation Instructions

⚠ CAUTION! *Danger of electrocution. The mounting/ installation of the Device should be done by a qualified person (electrician).*

⚠ CAUTION! *Danger of electrocution. Even when the Device is turned off, it is possible to have voltage across its clamps. Every change in the connection of the clamps has to be done after ensuring all local power is powered off/disconnected.*

⚠ CAUTION! *Connect the Device only in the way shown in these instructions. Any other method could cause damage and/or injury.*

⚠ CAUTION! *Use the Device only with power grid and appliances which comply with all applicable regulations. a short circuit in the power grid or any appliance connected to the Device may damage the Device.*

⚠ RECOMMENDATION! *The Device may be connected (wirelessly) to and may control electric circuits and appliances. Proceed with caution! Irresponsible attitude could lead to malfunction, danger to your life or violation of the law.*

⚠ RECOMMENDATION! *The Device may be connected with solid single-core cables with increased heat resistance to insulation not less than PVC T105°C.*

Declaration of conformity

Hereby, Allterco Robotics EOOD declares that the radio equipment type Shelly i3 is in compliance with Directive 2014/53/EU, 2014/35/EU, 2014/30/EU, 2011/65/EU. The full text of the EU declaration of conformity is available at the following internet address <https://shelly.cloud/knowledge-base/devices/shelly-i3/>

Manufacturer: Allterco Robotics EOOD

Address: Bulgaria, Sofia, 1407, 103 Cherni vrah Blvd.

Tel.: +359 2 988 7435

E-mail: support@shelly.cloud

Web: <http://www.shelly.cloud>

Changes in the contact data are published by the Manufacturer at the official website of the Device <http://www.shelly.cloud> All rights to trademarks She® and Shelly® , and other intellectual rights associated with this Device belong to Allterco Robotics EOOD.



